



str/nds

S 25 T

	Ø 25 / 28 mm		50Hz 105-210 350-700 445-890 1460-2900	60Hz 130-260 420-840 535-1070 1740-3480
	130 mm		0,75/0,95 kW	
	M16 / M20			
	MK 3			
	500 x 400 mm			



195

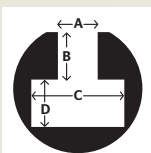

A 14,5 +/- 0,8 mm
B 13 mm
C 26 mm
D 12 mm

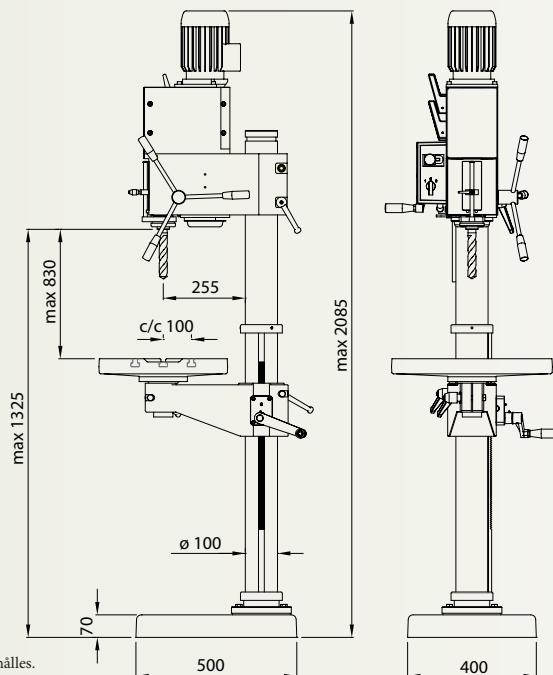

MSC 
Machinery
Scandinavia

Tillbehör S 25 T

Spare parts/Zubehör

strands



T25095

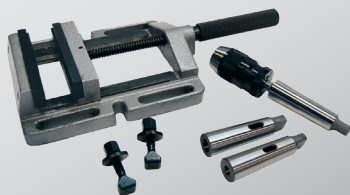

T25000

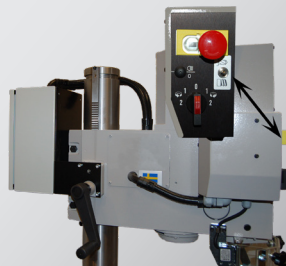

T25001



T25003



T25006

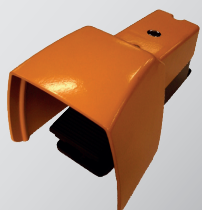

T25009

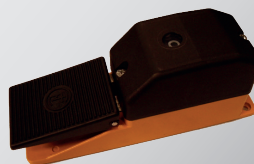

T25010

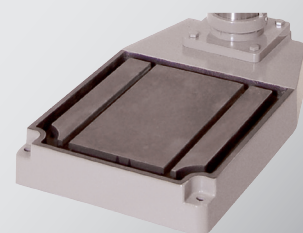

T25011



T25012



T25013



T25021

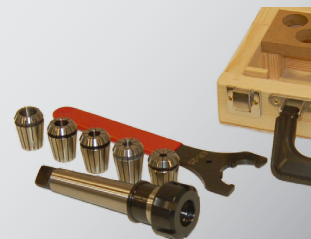

T25U42



T30040 0-13 mm



T30041 3-16 mm

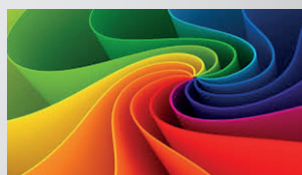

TFARGO

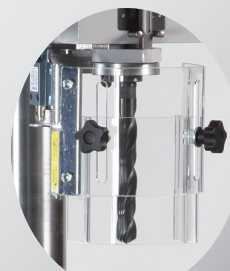

Std EU

T25014 + T25052

MSC 
**Machinery
Scandinavia**

Machinery Scandinavia AB
570 83 Rosenfors, Sweden
Tel +46 495 49 700
Fax + 46 495 207 30
E-mail: sales@mscab.se
www.strandsmachinery.com