



str/nds

S 30 F

50Hz			
	Ø 30 mm		50 - 1130 160 - 3800
	150 mm		1,2 kW
	M18 / M22		
	MK 3		
	500 x 400 mm		



256

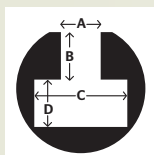

A 14,5 +/- 0,8 mm
B 13 mm
C 26 mm
D 12 mm

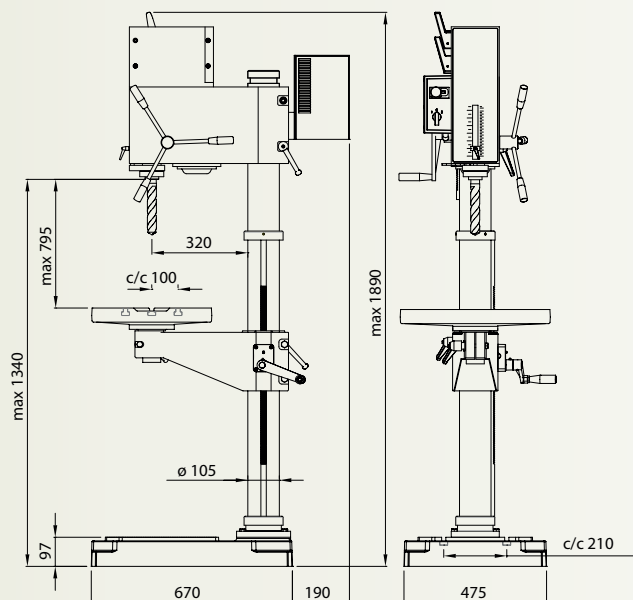

MSC
Machinery
Scandinavia

Rätt till ändringar av tekniska data utan föregående meddelande förbehålles.
We reserve the right to make modifications without prior warning.
Das recht auf Änderung der vorstehenden Daten behalten wir uns vor.

Tillbehör S 30 F

Spare parts/Zubehör

strands



T25095



T25000



T25003



T30006



T30009

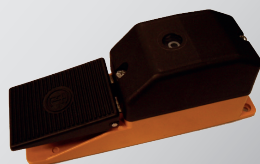

T30010



T30016



T30017



T25021

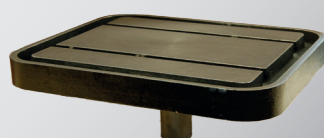

T35023

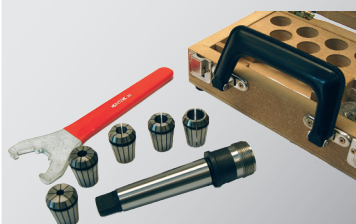

T25U42



T30040 0-13 mm



T30041 3-16 mm

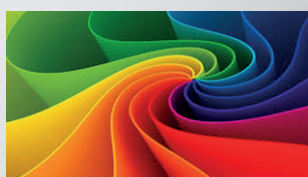

TFARGO

Std EU

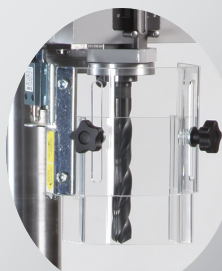

T25014 + T25052

MSC 
**Machinery
Scandinavia**

Machinery Scandinavia AB
570 83 Rosenfors, Sweden
Tel +46 495 49 700
Fax + 46 495 207 30
E-mail: sales@mscab.se
www.strandsmachinery.com



str/nds

S 30 MF

	Ø 30 mm		50Hz 50 - 1130 160 - 3800
	150 mm		1,2 kW
	M18 / M22		mm/r 0,10 0,15 0,22 0,30
	MK 3		
	500 x 400 mm		



263

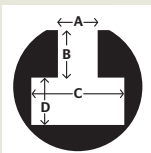

A 14,5 +/- 0,8 mm
B 13 mm
C 26 mm
D 12 mm

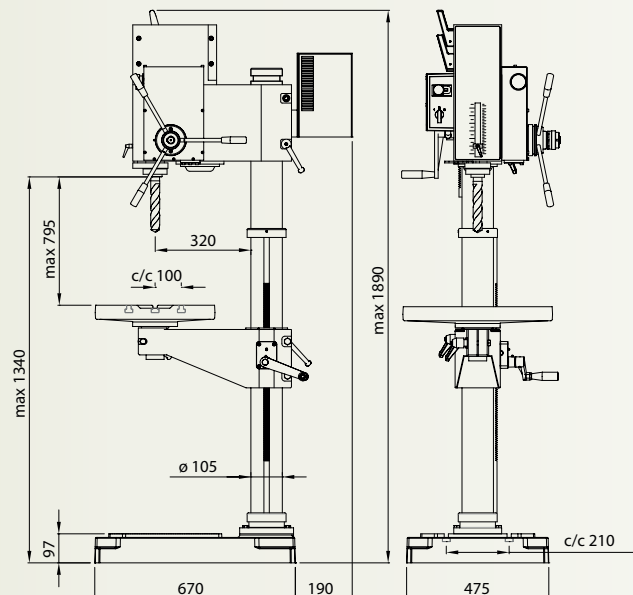

MSC 
Machinery
Scandinavia

Rätt till ändringar av tekniska data utan föregående meddelande förbehålles.
We reserve the right to make modifications without prior warning.
Das recht auf Änderung der vorstehenden Daten behalten wir uns vor.

Tillbehör S 30 MF

Spare parts/Zubehör

strands



T25095



T25000



T25003



T30006

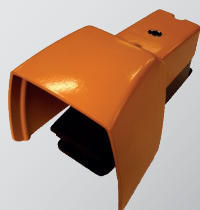

T30009

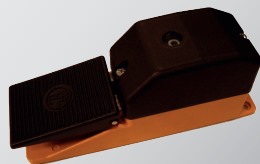

T30010



T30016



T30017



T25021

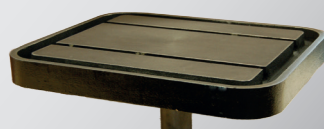

T35023

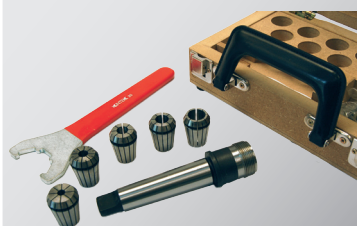

T25U42



T30040 0-13 mm



T30041 3-16 mm

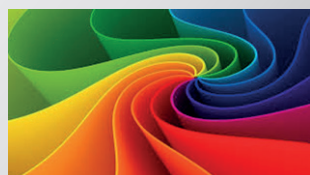

TFARGO

Std EU

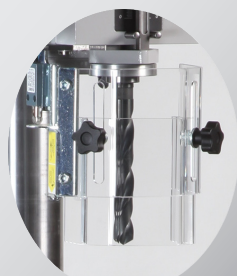

T25014 + T25052

MSC 
**Machinery
Scandinavia**

Machinery Scandinavia AB
570 83 Rosenfors, Sweden
Tel +46 495 49 700
Fax + 46 495 207 30
E-mail: sales@mscab.se
www.strandsmachinery.com