



str/nds

S 35

			50Hz	60Hz
	Ø 35 mm		75-160 265-440 535-890 1490-3010	90-190 320-640 530-1060 1790-3610
	150 mm		1,40/2,00 kW	1,60/2,20 kW
	M18 / M22			
	MK 4			
	500 x 400 mm			



290

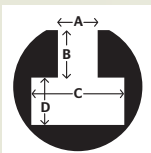

A 14,5 +/- 0,8 mm
B 13 mm
C 26 mm
D 12 mm

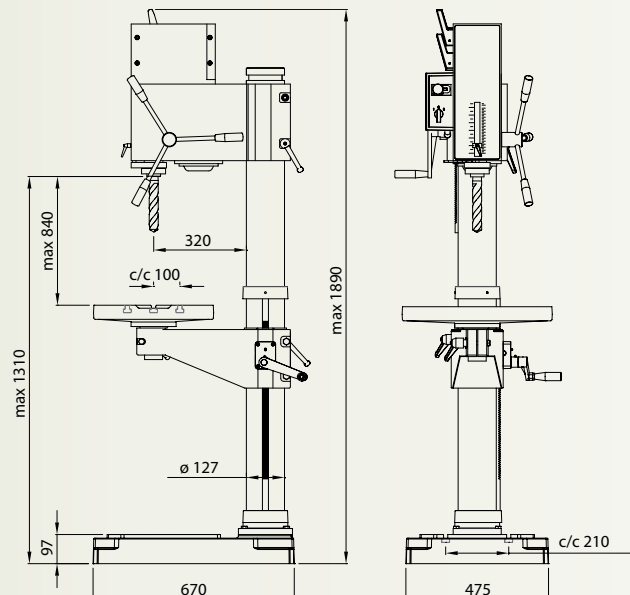

MSC 
Machinery
Scandinavia

Rätt till ändringar av tekniska data utan föregående meddelande förbehålles.
We reserve the right to make modifications without prior warning.
Das recht auf Änderung der vorstehenden Daten behalten wir uns vor.

Tillbehör S 35

Spare parts/Zubehör

strands



T25095



T35000

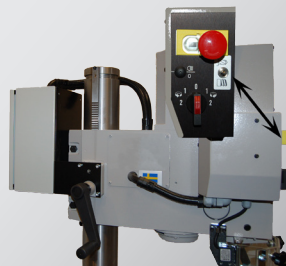

T35001



T25003



T30006



T35009

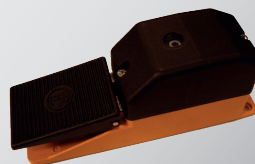

T35010



T35013



T35014



T25021

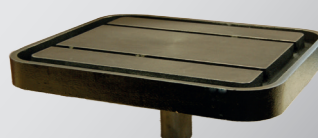

T35023

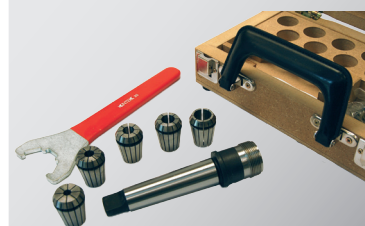

T40042



T40040

0-13 mm



T40041

3-16 mm

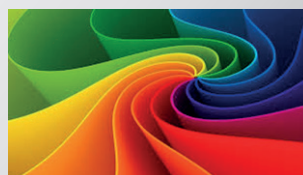

TFARGO

Std EU

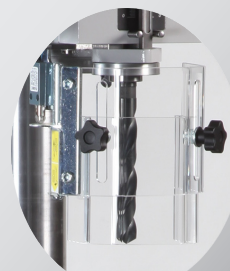

T25014 + T25052

MSC

Machinery
Scandinavia

Machinery Scandinavia AB
570 83 Rosenfors, Sweden
Tel +46 495 49 700
Fax + 46 495 207 30
E-mail: sales@mscab.se
www.strandsmachinery.com



str/nds

S 35 M

	Ø 35 mm		50Hz 75-160 265-440 535-890 1490-3010	60Hz 90-190 320-640 530-1060 1790-3610
				150 mm
	M18 / M22		mm/r inch/r	
				MK 4
	500 x 400 mm			



300

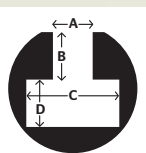

A 14,5 +/- 0,8 mm
 B 13 mm
 C 26 mm
 D 12 mm

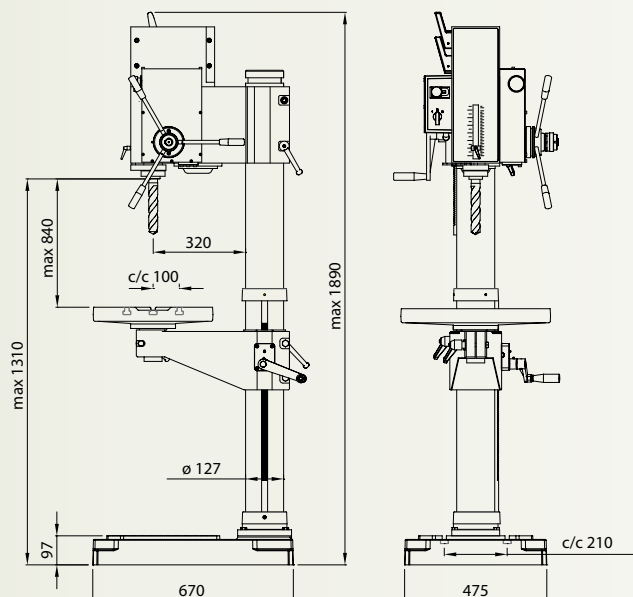

MSC 
Machinery
Scandinavia

Tillbehör S 35 M

Spare parts/Zubehör

strands



T25095



T35000

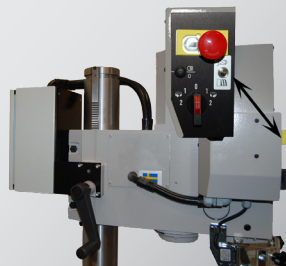

T35001



T25003



T30006

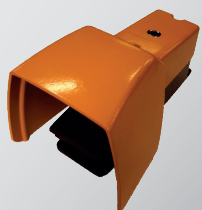

T35009

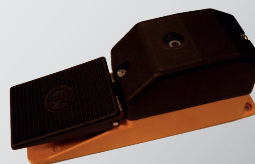

T35010



T35013

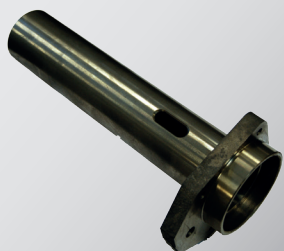

T35014



T25021

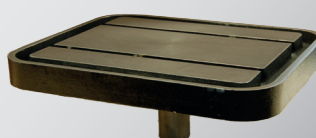

T35023

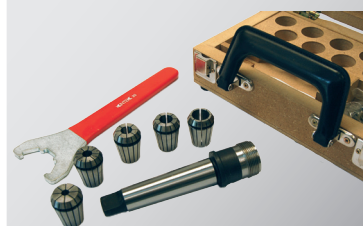

T40042



T40040

0-13 mm



T40041

3-16 mm

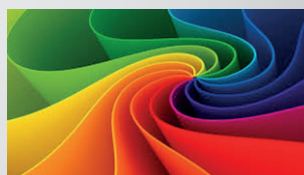

TFARGO

Std EU

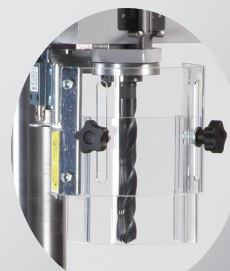

T25014 + T25052

MSC 
**Machinery
Scandinavia**

Machinery Scandinavia AB
570 83 Rosenfors, Sweden
Tel +46 495 49 700
Fax + 46 495 207 30
E-mail: sales@mscab.se
www.strandsmachinery.com



str/nds

S 35 ME

	Ø 35 mm		50Hz 75-160 265-440 535-890 1490-3010	60Hz 90-190 320-640 530-1060 1790-3610
				150 mm
	M18 / M22		mm/r inch/r	
			0,10 0,15 0,22 0,30	0,004 0,006 0,009 0,012
	MK 4			
	500 x 400 mm			



300

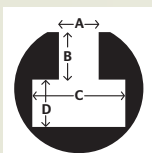

A 14,5 +/- 0,8 mm
 B 13 mm
 C 26 mm
 D 12 mm

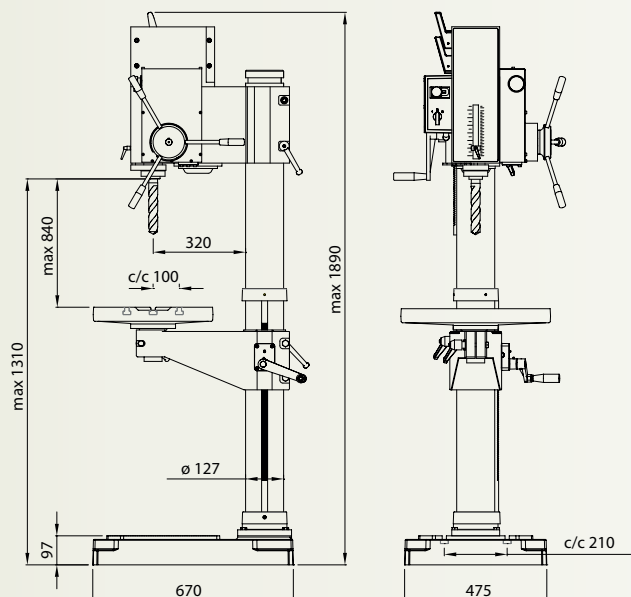

MSC 
Machinery
Scandinavia

Rätt till ändringar av tekniska data utan föregående meddelande förbehålles.
 We reserve the right to make modifications without prior warning.
 Das recht auf Änderung der vorstehenden Daten behalten wir uns vor.

Tillbehör S 35 ME

Spare parts/Zubehör

strands



T25095



T35000



T25003



T30006



T35009

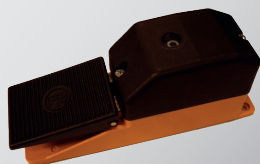

T35010



T35013



T35014



T25021

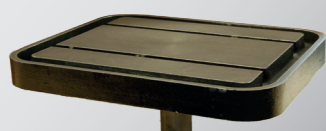

T35023

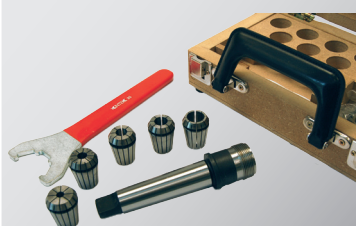

T40042



T40040 0-13 mm



T40041 3-16 mm

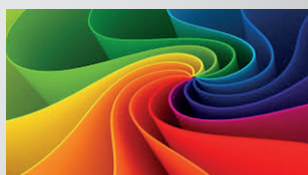

TFARGO

Std EU

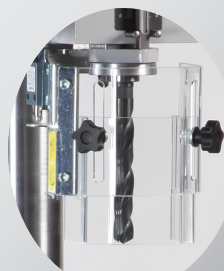

T25014 + T25052

MSC 
**Machinery
Scandinavia**

Machinery Scandinavia AB
570 83 Rosenfors, Sweden
Tel +46 495 49 700
Fax + 46 495 207 30
E-mail: sales@mscab.se
www.strandsmachinery.com